

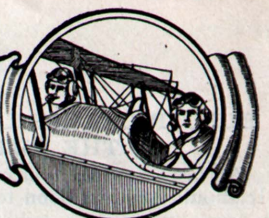

RADIO DEPARTMENT



The True Wireless

By NIKOLA TESLA

Written Exclusively for The Electrical Experimenter

EVER since the announcement of Maxwell's electro-magnetic theory scientific investigators all the world over had bent on its experimental verification. They were convinced that it would be done and lived in an atmosphere of eager expectancy, un-

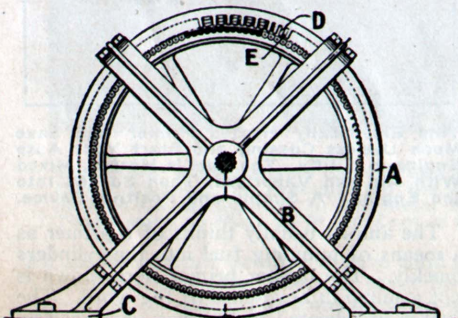

Alternator of 10,000 Cycles p.s., Capacity 10 K.W., Which Was Employed by Tesla in His First Demonstrations of High Frequency Phenomena Before the American Institute of Electrical Engineers at Columbia College, May 20, 1891. Fig. 1.

usually favorable to the reception of any evidence to this end. No wonder then that the publication of Dr. Heinrich Hertz's results caused a thrill as had scarcely ever been experienced before. At that time I was in the midst of pressing work in connection with the commercial introduction of my system of power transmission, but, nevertheless, caught the fire of enthusiasm and fairly burned with desire to behold the miracle with my own eyes. Accordingly, as soon as I had freed myself of these imperative duties and resumed research work in my laboratory on Grand Street, New York, I began, parallel with high frequency alternators, the construction of several forms of apparatus with the object of exploring the field opened up by Dr. Hertz. Recognizing the limitations of the devices he had employed, I concentrated my attention on the production of a powerful induction coil but made no notable progress until a happy inspiration led me to the invention of the oscillation transformer. In the latter part of 1891 I was already so far advanced in the development of this new principle that I had at my disposal means vastly superior

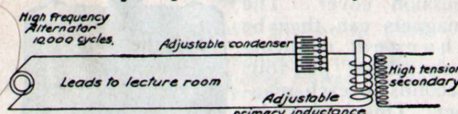

Diagram Illustrating the Circuit Connections and Tuning Devices Employed by Tesla in His Experimental Demonstrations Before the American Institute of Electrical Engineers With the High Frequency Alternator Shown in Fig. 1. Fig. 2.

to those of the German physicist. All my previous efforts with Rhumkorf coils had left me unconvinced, and in order to settle my doubts I went over the whole ground once more, very carefully, with these im-

proved appliances. Similar phenomena were noted, greatly magnified in intensity, but they were susceptible of a different and more plausible explanation. I considered this so important that in 1892 I went to Bonn, Germany, to confer with Dr. Hertz in regard to my observations. He seemed disappointed to such a degree that I regretted my trip and parted from him sorrowfully. During the succeeding years I made numerous experiments with the same object, but the results were uniformly negative. In 1900, however, after I had evolved a wireless transmitter which enabled me to obtain electro-magnetic activities of many millions of horse-power, I made a last desperate attempt to prove that the disturbances emanating from the oscillator were ether vibrations akin to those of light, but met again with utter failure. For more than eighteen years I have been reading treatises, reports of scientific transactions, and articles on Hertz-wave telegraphy, to keep myself informed, but they have always impress me like works of fiction.

The history of science shows that theories are perishable. With every new truth that is revealed we get a better understanding of Nature and our conceptions and views are modified. Dr. Hertz did not discover a new principle. He merely gave material support to a hypothesis which had

IN this remarkable and complete story of his discovery of the "True Wireless" and the principles upon which transmission and reception, even in the present day systems, are based, Dr. Nikola Tesla shows us that he is indeed the "Father of the Wireless." To him the Hertz wave theory is a delusion; it looks sound from certain angles, but the facts tend to prove that it is hollow and empty. He convinces us that the real Hertz waves are blotted out after they have traveled but a short distance from the sender. It follows, therefore, that the measured antenna current is no indication of the effect, because only a small part of it is effective at a distance. The limited activity of pure Hertz wave transmission and reception is here clearly explained, besides showing definitely that in spite of themselves, the radio engineers of today are employing the original Tesla tuned oscillatory system. He shows by examples with different forms of aërials that the signals picked up by the instruments must actually be induced by earth currents—not etheric space waves. Tesla also disproves the "Heaviside layer" theory from his personal observations and tests.

EDITOR.

been long ago formulated. It was a perfectly well-established fact that a circuit, traversed by a periodic current, emitted some kind of space waves, but we were in ignorance as to their character. He apparently gave an experimental proof that they were transversal vibrations in the ether. Most people look upon this as his great accomplishment. To my mind it seems that his immortal merit was not so much in this as in the focusing of the investigators' attention on the processes taking place in the ambient medium. The Hertz-wave theory, by its fascinating hold on the imagination, has stifled creative effort in the wireless art and retarded it for twenty-five years. But, on the other hand, it is impossible to over-estimate the beneficial effects of the powerful stimulus it has given in many directions.

As regards signaling without wires, the

application of these radiations for the purpose was quite obvious. When Dr. Hertz was asked whether such a system would be of practical value, he did not think so, and he was correct in his forecast. The best that might have been expected was a method of communication similar to the

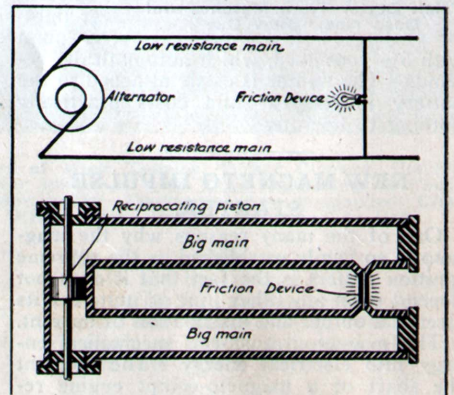

Electric Transmission Thru Two Wires and Hydraulic Analog. Fig. 3.

heliographic and subject to the same or even greater limitations.

In the spring of 1891 I gave my demonstrations with a high frequency machine before the American Institute of Electrical Engineers at Columbia College, which laid the foundation to a new and far more promising departure. Altho the laws of electrical resonance were well known at that time and my lamented friend, Dr. John Hopkinson, had even indicated their specific application to an alternator in the Proceedings of the Institute of Electrical Engineers, London, Nov. 13, 1889, nothing had been done towards the practical use of this knowledge and it is probable that those experiments of mine were the first public exhibition with resonant circuits, more particularly of high frequency. While the spontaneous success of my lecture was due to spectacular features, its chief import was in showing that all kinds of devices could be operated thru a single wire without return. This

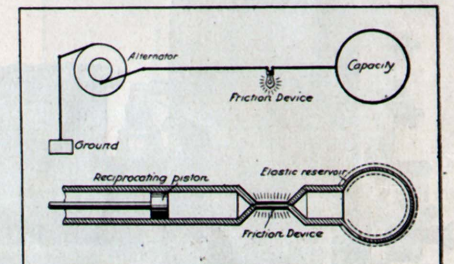

Electric Transmission Thru a Single Wire Hydraulic Analog. Fig. 4.

was the initial step in the evolution of my wireless system. The idea presented itself to me that it might be possible, under ob-

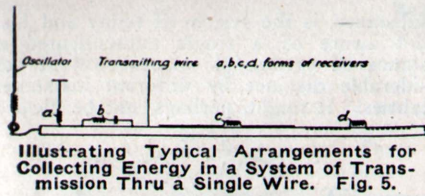

Illustrating Typical Arrangements for Collecting Energy in a System of Transmission Thru a Single Wire. Fig. 5.

servance of proper conditions of resonance, to transmit electric energy thru the earth, thus dispensing with all artificial conductors. Anyone who might wish to examine impartially the merit of that early suggestion must not view it in the light of present day science. I only need to say that as late as 1893, when I had prepared an elaborate chapter on my wireless system, dwelling on its various instrumentalities and future prospects, Mr. Joseph Wetzler and other friends of mine emphatically protested against its publication on the ground that such idle and far-fetched speculations would injure me in the opinion of conservative business men. So it came that only a small part of what I had intended to say was embodied in my address of that year before the Franklin Institute and National Electric Light Association under the chapter "On Electrical

number of radical improvements. Suitable high frequency generators and electrical oscillators had first to be produced. The energy of these had to be transformed in effective transmitters and collected at a distance in proper receivers. Such a system would be manifestly circumscribed in its usefulness if all extraneous interference were not prevented and exclusiveness secured. In time, however, I recognized that devices of this kind, to be most effect-

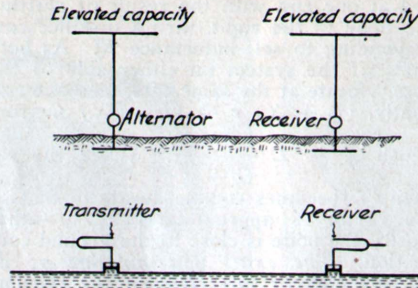

Transmission of Electrical Energy Thru the Earth as Illustrated in Tesla's Lectures Before the Franklin Institute and Electric Light Association in February and March, 1893, and Mechanical Analog of the Same. Fig. 7.

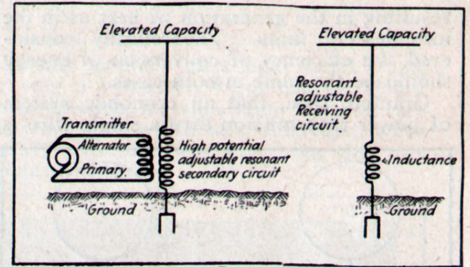

Tesla's System of Wireless Transmission Thru the Earth as Actually Exposed in His Lectures Before the Franklin Institute and Electric Light Association in February and March, 1893. Fig. 8.

of a condenser subdivided into small sections, the finer adjustments being effected by a movable iron core within an inductance coil. Loosely linked with the latter was a high tension secondary which was tuned to the primary.

The operation of devices thru a single wire without return was puzzling at first because of its novelty, but can be readily explained by suitable analogs. For this purpose reference is made to Figs. 3 and 4.

In the former the low resistance electric conductors are represented by pipes of large

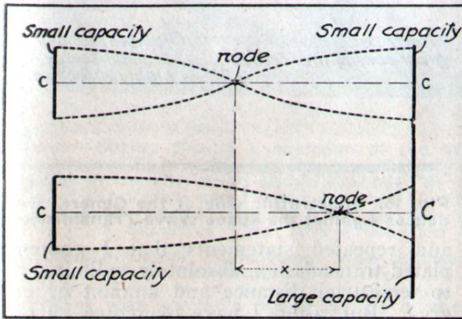

Diagram Elucidating Effect of Large Capacity on One End. Fig. 6.

ive and efficient, should be designed with due regard to the physical properties of this planet and the electrical conditions obtaining on the same. I will briefly touch upon the salient advances as they were made in the gradual development of the system.

The high frequency alternator employed in my first demonstrations is illustrated in Fig. 1. It comprised a field ring, with 384 pole projections and a disc armature with coils wound in one single layer which were connected in various ways according to requirements. It was an excellent machine for experimental purposes, furnishing sinusoidal currents of from 10,000 to 20,000 cycles per second. The output was comparatively large, due to the fact that as much as 30 amperes per square millimeter could be past thru the coils without injury.

The diagram in Fig. 2 shows the circuit arrangements as used in my lecture. Resonant conditions were maintained by means

The Forerunner of the Audion—the Most Sensitive Wireless Detector Known, as Described by Tesla in His Lecture Before the Institution of Electrical Engineers, London, February, 1892. Fig. 9.

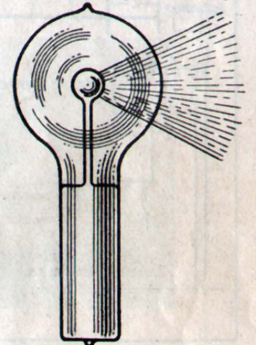

section, the alternator by an oscillating piston and the filament of an incandescent lamp by a minute channel connecting the pipes. It will be clear from a glance at the diagram that very slight excursions of the piston would cause the fluid to rush with high velocity thru the small channel and that virtually all the energy of movement would be transformed into heat by friction, similarly to that of the electric current in the lamp filament.

The second diagram will now be self explanatory. Corresponding to the terminal capacity of the electric system an elastic reservoir is employed which dispenses with the necessity of a return pipe. As the piston oscillates the bag expands and contracts, and the fluid is made to surge thru the restricted passage with great speed, this

Resonance." This little salvage from the wreck has earned me the title of "Father of the Wireless" from many well-disposed fellow workers, rather than the invention of scores of appliances which have brought wireless transmission within the reach of every young amateur and which, in a time not distant, will lead to undertakings overshadowing in magnitude and importance all past achievements of the engineer.

The popular impression is that my wireless work was begun in 1893, but as a matter of fact I spent the two preceding years in investigations, employing forms of apparatus, some of which were almost like those of today. It was clear to me from the very start that the successful consummation could only be brought about by a

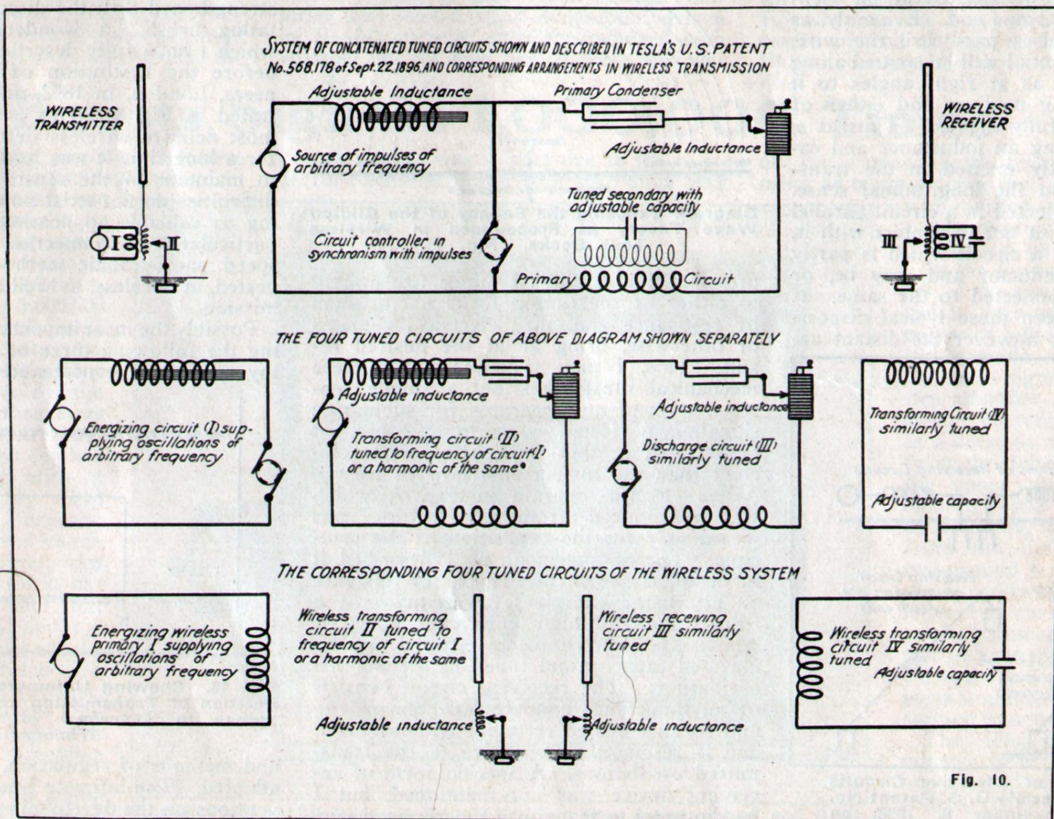
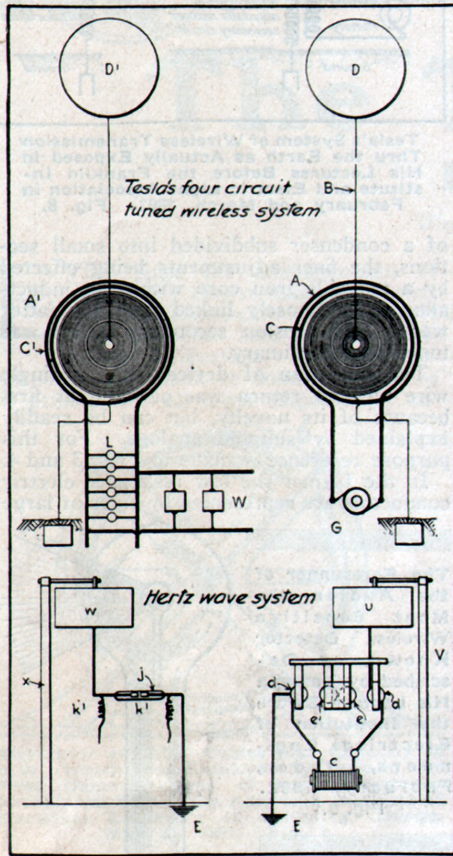

Fig. 10.

Tesla's System of Concatenated Tuned Circuits Shown and Described in U. S. Patent No. 568,178 of September 22, 1896, and Corresponding Arrangements in Wireless Transmission.

resulting in the generation of heat as in the incandescent lamp. Theoretically considered, the efficiency of conversion of energy should be the same in both cases.

Granted, then, that an economic system of power transmission thru a single wire is



Tesla's Four Circuit Tuned System Contrasted With the Contemporaneous Hertz-wave System. Fig. 11.

practicable, the question arises how to collect the energy in the receivers. With this object attention is called to Fig. 5, in which a conductor is shown excited by an oscillator joined to it at one end. Evidently, as the periodic impulses pass thru the wire, differences of potential will be created along the same as well as at right angles to it in the surrounding medium and either of these may be usefully applied. Thus at *a*, a circuit comprising an inductance and capacity is resonantly excited in the transverse, and at *b*, in the longitudinal sense. At *c*, energy is collected in a circuit parallel to the conductor but not in contact with it, and again at *d*, in a circuit which is partly sunk into the conductor and may be, or not, electrically connected to the same. It is important to keep these typical dispositions in mind, for however the distant ac-

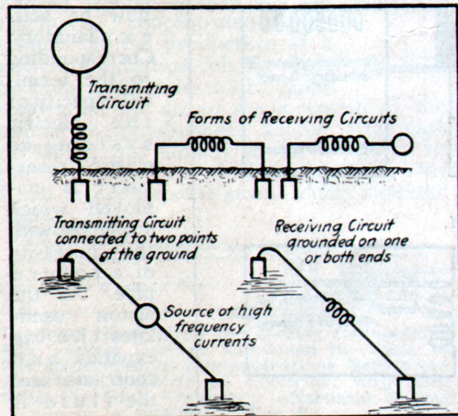

Arrangements of Directive Circuits Described in Tesla's U. S. Patent No. 613,809 of November 8, 1898, on "Method of and Apparatus for Controlling Mechanism of Moving Vessels or Vehicles." Fig. 12.

tions of the oscillator might be modified thru the immense extent of the globe the principles involved are the same.

Consider now the effect of such a conductor of vast dimensions on a circuit exciting it. The upper diagram of Fig. 6 illustrates a familiar oscillating system comprising a straight rod of self-inductance $2L$ with small terminal capacities cc and a node in the center. In the lower diagram of the figure a large capacity C is attached to the rod at one end with the result of shifting the node to the right, thru a distance corresponding to self-inductance X . As both parts of the system on either side of the node vibrate at the same rate, we have evidently, $(L + X) c = (L - X) C$ from

$$\text{which } X = L \frac{C - c}{C + c}$$

When the capacity C becomes commensurate to that of the earth, X approximates L , in other words, the node is close to the ground connection. The exact determination of its position is very important in the calculation of certain terrestrial electrical and geodetic data and I have devised special means with this purpose in view.

My original plan of transmitting energy without wires is shown in the upper diagram of Fig. 7, while the lower one illustrates its mechanical analog, first published in my article in the *Century Magazine* of June, 1900. An alternator, preferably of high tension, has one of its terminals connected to the ground and the other to an elevated capacity and impresses its oscillations upon the earth. At a distant point a receiving circuit, likewise connected to ground and to an elevated capacity, collects some of the energy and actuates a suitable device. I suggested a multiplication of such units in order to intensify the effects, an idea which may yet prove valuable. In the analog two tuning forks are provided, one at the sending and the other at the receiving station, each having attached to its lower prong a piston fitting in a cylinder. The two cylinders communicate with a large elastic reservoir filled with an incom-

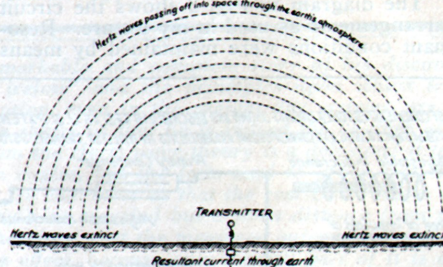

Diagram Exposing the Fallacy of the Gliding Wave Theory as Propounded in Wireless Text Books. Fig. 13.

pressible fluid. The vibrations transmitted to either of the tuning forks excite them by resonance and, thru electrical contacts or otherwise, bring about the desired result. This, I may say, was not a mere mechanical illustration, but a simple representation of my apparatus for submarine signaling, perfected by me in 1892, but not appreciated at that time, altho more efficient than the instruments now in use.

The electric diagram in Fig. 7, which was reproduced from my lecture, was meant only for the exposition of the principle. The arrangement, as I described it in detail, is shown in Fig. 8. In this case an alternator energizes the primary of a transformer, the high tension secondary of which is connected to the ground and an elevated capacity and tuned to the impress oscillations. The receiving circuit consists of an inductance connected to the ground and to an elevated terminal without break and is resonantly responsive to the transmitted oscillations. A specific form of receiving device was not mentioned, but I had in mind to transform the received currents and thus make their volume and tension suitable for any purpose. This, in

substance, is the system of today and I am not aware of a single authenticated instance of successful transmission at considerable distance by different instrumentalities. It might, perhaps, not be clear to

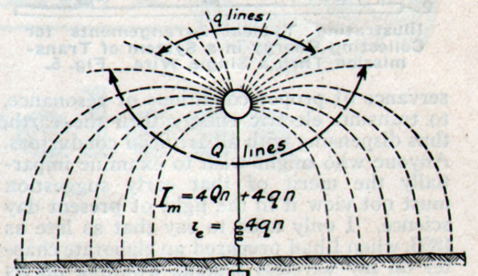

Fig. 14. Diagram Explaining the Relation Between the Effective and the Measured Current in the Antenna.

those who have perused my first description of these improvements that, besides making known new and efficient types of apparatus, I gave to the world a wireless system of potentialities far beyond anything before conceived. I made explicit

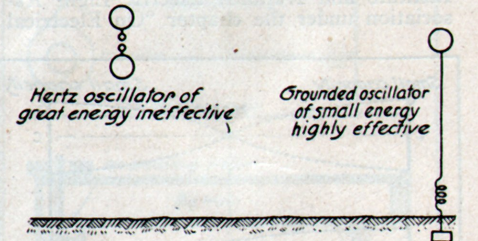

Fig. 15. Illustrating One of the General Evidences Against the Space Wave Transmission.

and repeated statements that I contemplated transmission, absolutely unlimited as to terrestrial distance and amount of energy. But, altho I have overcome all obstacles which seemed in the beginning unsurmountable and found elegant solutions of all the problems which confronted me, yet, even at this very day, the majority of experts are still blind to the possibilities which are within easy attainment.

My confidence that a signal could be easily flashed around the globe was strengthened thru the discovery of the "rotating brush," a wonderful phenomenon which I have fully described in my address before the Institution of Electrical Engineers, London, in 1892, and which is illustrated in Fig. 9. This is undoubtedly the most delicate wireless detector known, but for a long time it was hard to produce and to maintain in the sensitive state. These difficulties do not exist now and I am looking to valuable applications of this device, particularly in connection with the high-speed photographic method, which I suggested, in wireless, as well as in wire, transmission.

Possibly the most important advances during the following three or four years were my system of concatenated tuned circuits

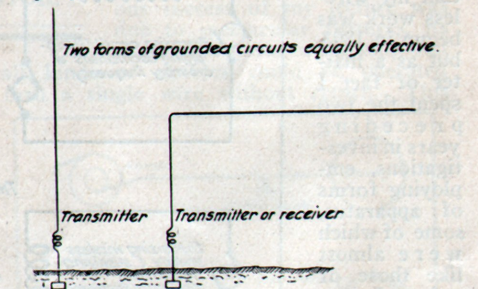

Fig. 16. Showing Unimportance of Relative Position of Transmitting and Receiving Antennae in Disproof of the Hertz-wave Theory.

and methods of regulation, now universally adopted. The intimate bearing of these inventions on the development of the wireless art will appear from Fig. 10, which illustrates

(Continued on page 61)

The True Wireless

By Nikola Tesla

(Continued from page 30)

brates an arrangement described in my U. S. Patent No. 568178 of September 22, 1896, and corresponding dispositions of wireless apparatus. The captions of the individual diagrams are thought sufficiently explicit to dispense with further comment. I will merely remark that in this early record, in addition to indicating how any number of resonant circuits may be linked and regulated, I have shown the advantage of the proper timing of primary impulses and use of harmonics. In a farcical wireless suit in London, some engineers, reckless of their reputation, have claimed that my circuits were not at all attuned; in fact they asserted that I had looked upon resonance as a sort of wild and untamable beast!

It will be of interest to compare my system as first described in a Belgian patent of 1897 with the Hertz-wave system of that period. The significant differences between them will be observed at a glance. The first enables us to transmit economically energy to any distance and is of inestimable value; the latter is capable of a radius of only a few miles and is worthless. In the first there are no spark-gaps and the actions are enormously magnified by resonance. In both transmitter and receiver the currents are transformed and rendered more effective and suitable for the operation of any desired device. Properly constructed, my system is safe against static and other interference and the amount of energy which may be transmitted is *billions of times greater* than with the Hertzian which has none of these virtues, and of which no trace can be found at present.

A well-advertised expert gave out a statement in 1899 that my apparatus did not work and that it would take 200 years before a message would be flashed across the Atlantic and he even accepted stolidly my congratulations on a supposed great feat. But subsequent examination of the records showed that my devices were secretly used all the time and ever since I learned of this I have treated these Borgia-Medici methods with the contempt in which they are held by all fair-minded men. The wholesale appropriation of my inventions was, however, not always without a diverting side. As an example to the point I may mention my oscillation transformer operating with an air gap. This was in turn replaced by a carbon arc, quenched gap, an atmosphere of hydrogen, argon or helium, by a mechanical break with oppositely rotating members, a mercury interrupter or some kind of a vacuum bulb and by such *tours de force* as many new "systems" have been produced. I refer to this of course, without the slightest ill-feeling, let us advance by all means. But I cannot help thinking how much better it would have been if the ingenious men, who have originated these "systems," had invented something of their own instead of depending on me altogether.

Before 1900 two most valuable improvements were made. One of these was my individualized system with transmitters emitting a wave-complex and receivers comprising separate tuned elements cooperatively associated. The underlying principle can be explained in a few words. Suppose that there are *n* simple vibrations suitable for use in wireless transmission, the probability that any one tune will be struck by an

extraneous disturbance is $\frac{1}{n}$. There will then remain *n*-1 vibrations and the chance that one of these will be excited is $\frac{1}{n-1}$ hence the probability that two tunes would

WANTED!

- OFFICE MEN**
Auditors, Accountants, Office Managers, Credit Men, Cashiers, Bookkeepers and Cost Clerks—\$1,200 to \$7,500.
- FACTORY MEN**
Electrical and Mechanical Engineers, Factory Managers, Superintendents, Foremen, Designers, Draftsmen—\$1,500 to \$12,000.
- CONSTRUCTION MEN**
Civil and Structural Engineers, Transmitters, Construction Superintendents and Foremen, Estimators, Designers and Draftsmen—\$1,200 to \$10,000.
- TRADES**—Machinists and Tool-makers, Auto Repairers, Electricians, Stationary Engineers, Firemen, Plumbers, Carpenters, etc.—\$1,200 to \$2,000.

All these positions were advertised in a single issue of a Chicago newspaper

These books were written by experts in plain, everyday language. They are free from puzzling technical terms. Numerous illustrations, diagrams and tables make difficult points as simple as A-B-C. They are handsomely bound in half or full leather (except Law and Practice, which is bound in law buckram) and stamped in gold. Fill out the coupon.

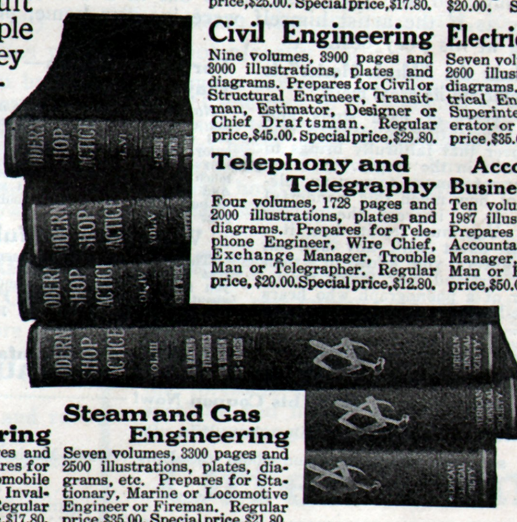

Automobile Engineering

Five volumes, 2400 pages and 2000 illustrations. Prepares for Garage Foreman, Automobile Mechanic or Chauffeur. Invaluable to car owners. Regular price, \$25.00. Special price, \$17.80.

Steam and Gas Engineering

Seven volumes, 3300 pages and 2500 illustrations, plates, diagrams, etc. Prepares for Stationary, Marine or Locomotive Engineer or Fireman. Regular price, \$35.00. Special price, \$21.80.

Machine Shop Practice

Six volumes, 2300 pages and 2500 illustrations. Prepares for Machine Shop Superintendent or Foreman, Foundryman, Pattern Maker, Tool Designer or Tool Maker. Regular price, \$30.00. Special price, \$19.80.

Law and Practice

(with Reading Course in 25 bound pamphlets). Thirteen volumes, 6000 pages and 24 illustrations. Prepares for all Bar Examinations. A wonderful aid to business men. Regular price, \$72.00. Special price, \$39.80.

Sanitary, Heating and Ventilating Engineering

Four volumes, 1454 pages and more than 1400 illustrations, etc. Prepares for Sanitary Engineer, Heating and Ventilating Engineer, Master Plumber or Plumber. Regular price, \$20.00. Special price, \$13.80.

Practical Accounting

Four volumes, 1840 pages and 800 illustrations, plates and diagrams. C. P. A. questions and practical problems. Prepares for Accountant, Bookkeeper or Cost Clerk. Regular price, \$20.00. Special price, \$12.80.

50c A WEEK

Yes, if you decide to keep the set you have selected, send \$2 within seven days and then \$2 a month (50c a week) until the present low price has been paid. Have you ever heard of a more generous offer? Remember, you take no chances whatever—we send the books for examination and you are not obliged to keep them if you do not care to buy. Mail the coupon *now*—before you turn the page.

Which Job Can You Fill?

Which one of them could you fill? If you haven't the knowledge necessary to break into the *big-pay class*, decide to *get that knowledge NOW!* Any of the books listed below will quickly fit you for a well-paid job—at home—in your spare time.

Carpentry and Contracting

Five volumes, 2138 pages and more than 400 illustrations. Prepares for Contractor, Building Superintendent and Carpenter Foreman. Regular price, \$25.00. Special price, \$17.80.

Fire Prevention and Insurance

Four volumes, 1500 pages and 600 illustrations, diagrams, forms, etc. Prepares for Counterforeman, Rate Clerk, Inspector or Agent. Regular price, \$20.00. Special price, \$15.80.

Civil Engineering

Nine volumes, 3900 pages and 3000 illustrations, plates and diagrams. Prepares for Civil or Structural Engineer, Transmitter, Estimator, Designer or Chief Draftsman. Regular price, \$45.00. Special price, \$29.80.

Electrical Engineering

Seven volumes, 3000 pages and 2500 illustrations, plates and diagrams. Prepares for Electrical Engineer, Power Plant Superintendent, Substation Operator or Electrician. Regular price, \$35.00. Special price, \$19.80.

Telephony and Telegraphy

Four volumes, 1728 pages and 2000 illustrations, plates and diagrams. Prepares for Telephone Engineer, Wire Chief, Exchange Manager, Trouble Man or Telegrapher. Regular price, \$20.00. Special price, \$12.80.

Accountancy and Business Management

Ten volumes, 3680 pages and 1987 illustrations, forms, etc. Prepares for Certified Public Accountant, Auditor, Office Manager, Accountant, Credit Man or Bookkeeper. Regular price, \$50.00. Special price, \$24.80.

One Week Free Trial

We'll gladly send you any set for seven days' examination. Don't send us a penny; just pay the small shipping charge when the books arrive. Examine them carefully—use them at your work for an entire week. At the end of that time, if you feel they aren't worth far more than we ask, return them *at our expense*. If you keep them, pay the bargain price on the easy terms explained below.

American Technical Society
Dept. X3385 Chicago, U. S. A.

American Technical Society, Dept. X3385, Chicago, Ill.

Please send me set of.....
for 7 days' examination, shipping charges collect. I will examine the books thoroughly and, if satisfied, will send \$2 within 7 days and \$2 each month until I have paid the special price of..... If I decide not to keep the books, set is fully paid for.

Name.....
Address.....
Reference.....

Learn Watchwork, Jewelrywork and Engraving A fine trade commanding a good salary, and your services are always in demand. Address **HOROLOGICAL Department, Bradley Institute, Peoria, Ill.** for our latest catalog.

WRITE THE WORDS FOR A SONG
We write music, guarantee publisher's acceptance. Submit poems on patriotism, love or any subject.
CHESTER MUSIC COMPANY
918 S. Michigan Ave., Room 313 Chicago, Illinois

be struck at the same time is $\frac{1}{n(n-1)}$. Similarly, for a combination of three the chance will be $\frac{1}{n(n-1)(n-2)}$ and so on. It will be readily seen that in this manner any desired degree of safety against the statics or other kind of disturbance can be attained provided the receiving apparatus is so designed that its operation is possible only thru the joint action of all the tuned elements. This was a difficult problem which I have successfully solved so that now any desired number of simultaneous messages is practicable in the transmission thru the earth as well as thru artificial conductors.

The other invention, of still greater importance, is a peculiar oscillator enabling the transmission of energy without wires in any quantity that may ever be required for industrial use, to any distance, and with very high economy. It was the outcome of years of systematic study and investigation and wonders will be achieved by its means.

The prevailing misconception of the mechanism involved in the wireless transmission has been responsible for various unwarranted announcements which have misled the public and worked harm. By keeping steadily in mind that the transmission thru the earth is in every respect identical to that thru a straight wire, one will gain a clear understanding of the phenomena and will be able to judge correctly the merits of a new scheme. Without wishing to detract from the value of any plan that has been put forward I may say that they are devoid of novelty. So for instance in Fig. 12 arrangements of transmitting and receiving circuits are illustrated, which I have described in my U. S. Patent No. 613809 of November 8, 1898 on a Method of and Apparatus for Controlling Mechanism of Moving Vessels or Vehicles, and which have been recently dished up as original discoveries. In other patents and technical publications I have suggested conductors in the ground as one of the obvious modifications indicated in Fig. 5.

For the same reason the statics are still the bane of the wireless. There is about as much virtue in the remedies recently proposed as in hair restorers. *A small and compact apparatus has been produced which does away entirely with this trouble, at least in plants suitably remodelled.*

Nothing is more important in the present phase of development of the wireless art than to dispose of the dominating erroneous ideas. With this object I shall advance a few arguments based on my own observations which prove that Hertz waves have little to do with the results obtained even at small distances.

In Fig. 13 a transmitter is shown radiating space waves of considerable frequency. It is generally believed that these waves pass along the earth's surface and thus affect the receivers. I can hardly think of anything more improbable than this "gliding wave" theory and the conception of the "guided wireless" which are contrary to all laws of action and reaction. Why should these disturbances cling to a conductor where they are counteracted by induced currents, when they can propagate in all other directions unimpeded? The fact is that the radiations of the transmitter passing along the earth's surface are soon extinguished, the height of the inactive zone indicated in the diagram, being some function of the wave length, the bulk of the waves traversing freely the atmosphere. Terrestrial phenomena which I have noted conclusively show that there is no Heaviside layer, or if it exists, it is of no effect. It certainly would be unfortunate if the human race were thus imprisoned and forever without power to reach out into the depths of space.

The actions at a distance cannot be proportionate to the height of the antenna and the current in the same. I shall endeavor to make this clear by reference to diagram in Fig. 14. The elevated terminal charged to a high potential induces an equal and opposite charge in the earth and there are thus Q lines giving an average current $I = 4Qn$ which circulates locally and is useless except that it adds to the momentum. A relatively small number of lines q however, go off to great distance and to these corresponds a mean current of $ie = 4qn$ to which is due the action at a distance. The total average current in the antenna is thus $I_m = 4Qn + 4qn$ and its intensity is no criterion for the performance. The

electric efficiency of the antenna is $\frac{q}{Q+q}$ and this is often a very small fraction.

Dr. L. W. Austin and Mr. J. L. Hogan have made quantitative measurements which are valuable, but far from supporting the Hertz wave theory they are evidences in disproof of the same, as will be easily perceived by taking the above facts into consideration. Dr. Austin's researches are especially useful and instructive and I regret that I cannot agree with him on this subject. I do not think that if his receiver was affected by Hertz waves he could ever establish such relations as he has found, but he would be likely to reach these results if the Hertz waves were in a large part eliminated. At great distance the space waves and the current waves are of equal energy, the former being merely an accompanying manifestation of the latter in accordance with the fundamental teachings of Maxwell.

It occurs to me here to ask the question—why have the Hertz waves been reduced from the original frequencies to those I have advocated for my system, when in so doing the activity of the transmitting apparatus has been reduced a billion fold? I can invite any expert to perform an experiment such as is illustrated in Fig. 15, which shows the classical Hertz oscillator and my grounded transmitting circuit. It is a fact which I have demonstrated that, altho we may have in the Hertz oscillator an activity thousands of times greater, the effect on the receiver is not to be compared to that of the grounded circuit. This shows that in the transmission from an airplane we are merely working thru a condenser, the capacity of which is a function of a logarithmic ratio between the length of the conductor and the distance from the ground. The receiver is affected in exactly the same manner as from an ordinary transmitter, the only difference being that there is a certain modification of the action which can be predetermined from the electrical constants. It is not at all difficult to maintain communication between an airplane and a station on the ground, on the contrary, the feat is very easy.

To mention another experiment in support of my view, I may refer to Fig. 16 in which two grounded circuits are shown excited by oscillations of the Hertzian order. It will be found that the antennas can be put out of parallelism without noticeable change in the action on the receiver, this proving that it is due to currents propagated thru the ground and not to space waves.

Particularly significant are the results obtained in cases illustrated in Figures 17 and 18. In the former an obstacle is shown in the path of the waves but unless the receiver is within the effective electrostatic influence of the mountain range, the signals are not appreciably weakened by the presence of the latter, because the currents pass under it and excite the circuit in the same way as if it were attached to an energized wire. If, as in Fig. 18, a second range happens to be beyond the receiver, it could only strengthen the Hertz wave effect by reflection, but as a matter of fact it detracts

(Continued on page 87)

The True Wireless

By Nikola Tesla

(Continued from page 63)

greatly from the intensity of the received impulses because the electric niveau between the mountains is raised, as I have explained in connection with my lightning protector in the EXPERIMENTER of February.

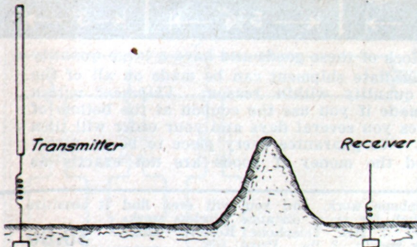

Fig. 17. Illustrating Influence of Obstacle in the Path of Transmission as Evidence Against the Hertz-wave Theory.

Again in Fig. 19 two transmitting circuits, one grounded directly and the other thru an air gap, are shown. It is a common observation that the former is far

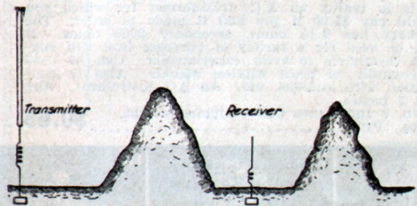

Fig. 18. Showing Effect of Two Hills as Further Proof Against the Hertz-wave Theory.

more effective, which could not be the case in a transmission with Hertz radiations. In like manner if two grounded circuits are

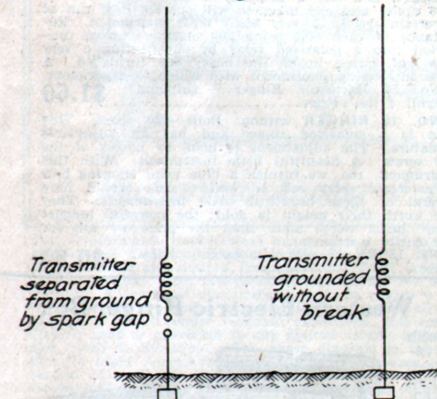

Fig. 19. Comparing the Actions of Two Forms of Transmitter as Bearing Out the Fallacy of the Hertz-wave Theory.

observed from day to day the effect is found to increase greatly with the dampness of the ground, and for the same reason

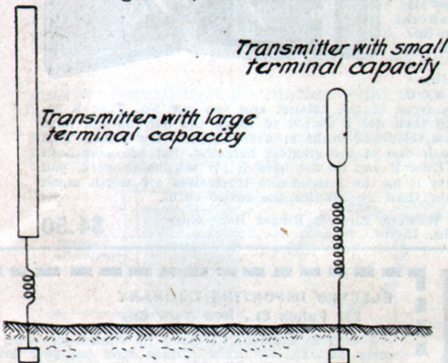

Fig. 20. Disproving the Hertz-wave Theory by Two Transmitters, One of Great and the Other of Small Energy.

also the transmission thru sea-water is more efficient.

An illuminating experiment is indicated in Fig. 20 in which two grounded transmitters are shown, one with a large and the other with a small terminal capacity. Suppose that the latter be 1/10 of the former but that it is charged to 10 times the potential and let the frequency of the two circuits and therefore the currents in both antennas be exactly the same. The circuit with the smaller capacity will then have 10 times the energy of the other but the effects on the receiver will be in no wise proportionate.

The same conclusions will be reached by transmitting and receiving circuits with wires buried underground. In each case the actions carefully investigated will be found to be due to earth currents. Numerous other proofs might be cited which can be easily verified. So for example oscillations of low frequency are ever so much more effective in the transmission which is inconsistent with the prevailing idea. My observations in 1900 and the recent transmissions of signals to very great distances are another emphatic disproof.

The Hertz wave theory of wireless transmission may be kept up for a while, but I do not hesitate to say that in a short time it will be recognized as one of the most remarkable and inexplicable aberrations of the scientific mind which has ever been recorded in history.

TO ALL RADIO AMATEURS

We have received many thousands of communications from radio amateurs for the past few months asking us about the status of their radio stations, and when they will be allowed to operate them again.

Inasmuch as there has been no official information as to the reopening of amateur stations, during the armistice, we can only say that in all likelihood, amateurs will not be allowed to operate until actual peace has been signed. In his executive order of April the 6th, 1917, President Wilson closed all radio stations in the United States by an act approved in the Radio Law of August 13, 1912.

Such a measure, according to law, is only for the duration of the war, there being at present no legislation which prevents any station, amateur or otherwise, from operating after peace has actually been declared. Therefore, the minute newspapers announce that peace between the United States and the Central Powers has been signed, all amateur stations automatically revert to their former status, and amateurs need not wait for permission to operate their stations, once peace has been declared.

EDITOR.

WRINKLES, RECIPES & FORMULAS.

(Continued from page 42)

If carbon dioxide is to be generated, fill tube A with marble chips and tube B with dilute hydrochloric acid.

It is evident that the parts of the generator can be easily cleaned and new chemicals put in. The completed apparatus is shown in Fig. 3.

Contributed by S. WEISINGER, JR.



Strengthen Your EYES!

Preserve Your Most Precious Possession

Your sight is your most precious gift. Weak eyesight means weak power of observation, eye strain, eye disease, and untold inconvenience. Take no chances with your eyes—you cannot get along without them. Make them stronger every day instead of weaker. Let us send you Bernarr Macfadden's wonderful new Course in "Strengthening the Eyes." Send no money—just mail coupon.

Glasses Do Not Remove the Cause of Eye Trouble

Instead, the eyes come to depend on them more every day. Glasses are eye crutches! They simply bolster up the eyes—they do not strengthen them. It has been definitely proven that practically all defects of the eyes can be cured without glasses. Most people now wearing glasses can be freed from the inconvenience, and expense of constant breakages, by strengthening and correcting their vision through the simple, yet effective eye educational exercises recommended by Mr. Macfadden.

Eye Defects Removed

This remarkable new Course teaches you how to use your eyes without strain at all distances—how to do without glasses—how to remedy cross eyes or squint eyes—how to restore the normal sight—how to restore perfect control to eye nerves and muscles.

Beneficial Results at Once

No drugs, medicines or operations. The Course includes a simple, yet thoroughly scientific system of eye educational exercises which strengthen the eyes exactly as the muscles of the body can be strengthened through body exercises. Results are immediate, and improvement continues daily. One woman writes: "I notice a great improvement in my eyes since learning to use them right." Another user says, "Your Eye Strengthening Course is fine. My eyes are already improving." Still another writes, "Words cannot express my great gratitude for these excellent books." (Names on request.)

Send No Money

Let us send you this new Course "Strengthening the Eyes" on five days' approval. There are twenty-eight simple little lessons which will show you the way to strengthen and preserve your sight—the gift of the gods! Try the exercises, then return the Course if not satisfied and you will owe nothing. If, however, you feel that the Course will help your eyes wonderfully, send only \$5.00.

Mail Coupon!

If you value your eyes, if you wear glasses and want to get rid of them, if your eyes are weak or strained, or if you want to insure freedom from eye troubles, mail coupon now and investigate this New Course "Strengthening the Eyes." Send no money—but mail coupon now, as this offer may never appear again.

Physical Culture Publishing Company

Dept. 5605
119 West
40th Street
N. Y. C.

Physical Culture Pub. Co.
Dept. 5605
119 W. 40th St.
New York City

Gentlemen:
Send me your Course "Strengthening the Eyes" which I will return in 5 days or send you \$5 in payment for the course.

Name
Address



WANTED — Railway Mail Clerks

Age 18 to 35
\$1100 to \$2000 Year

Common Education Sufficient

Sure pay. Life job.

Pull unnecessary.

ACCOUNTANCY

The Highest Paid Profession taught thorough in a few months of home study by new system FREE BOOK International Accountants Association

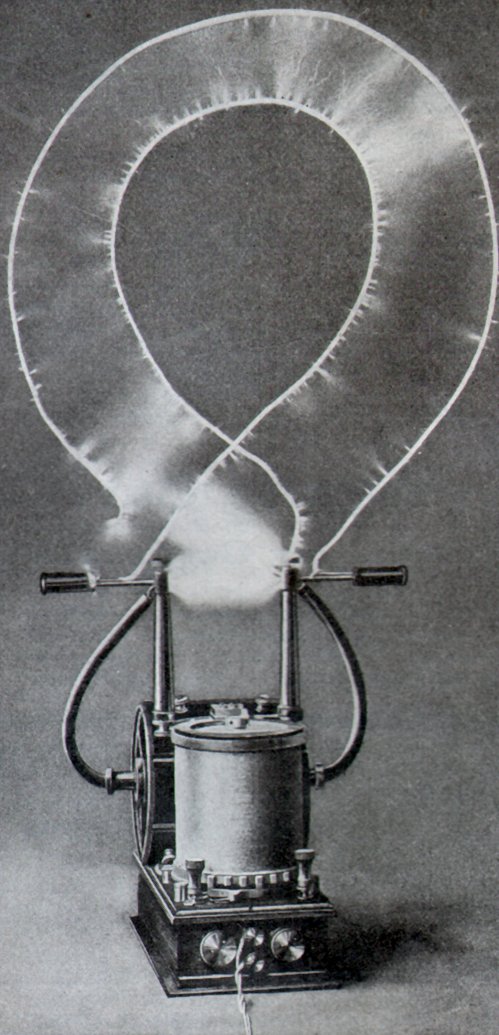

Fig. 1—Tesla Oscillation Transformer (Tesla Coil) Presented by Lord Kelvin Before the British Association in August, 1897. This Small and Compact Instrument, Only 8 Inches High, Developed Two Square Feet of Streamers With Twenty-Five Watts From the 110 Volt D. C. Supply Circuit. The Instrument Contains a Tesla Primary and Secondary, Condenser, and a Circuit Controller.

Copyright, 1919, by E. P. Co. All rights reserved

Mr. Tesla's articles started in our February issue